

REACH & RoHS
COMPLIANT

REV.	ECN / DESCRIPTION	BY	DATE
A0	NEW	ZG.Hu	2018.09.20

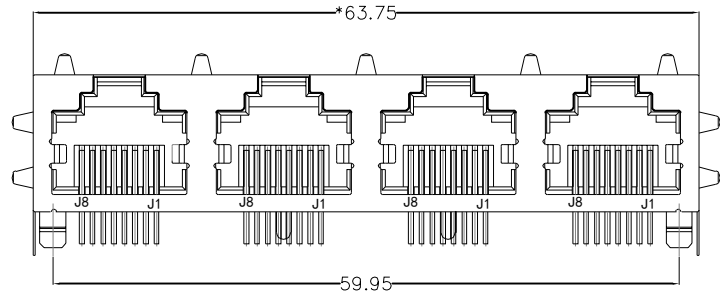

FRONT VIEW

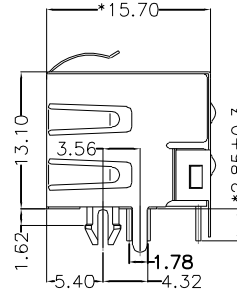

RIGHT SIDE VIEW

MATERIAL:

HOUSING: PBT,UL94V-0,BLACK.
TERMINAL: PHOSPHOR BRONZE $\phi=0.46\text{MM}$,
G/FU" GOLD PLATING ON CONTACT AREA.
SHIELD: C2680,T=0.20MM,20 MIN NICKEL PLATING
ON ALL AREA.

MACHANICAL:

DURABILITY: 750 CYCLES MIN,12.5MM/MINUTE.
INSERTION FORCE: 2.2KG.F MAX.
RETENTION STRENGTH : 7.7KG.F BETWEEN JACK AND PLUG.
OPERATING TEMPERATURE: $-40^{\circ}\text{C}\sim+85^{\circ}\text{C}$.
STORAGE TEMPERATURE: $-40^{\circ}\text{C}\sim+85^{\circ}\text{C}$.
ALL CRITICAL DIMENSIONS WITH "*"

ELECTRICAL:

VOLTAGE: 125 VOLTS AC.
CURRENT RATING: 1.5AMP.
DIELECTRIC STRENGTH: 1000 VAC RMS 50HZ OR 60HZ,1MIN.
INSULATION RESISTANCE: 500 MEGA OHMS MIN. INITIAL
AFTER 500V DC FOR 1 MINUTE.
CONTACT RESISTANCE: SINGLE TERMINAL 30 MILLIOHMS MAX.
INITIAL 50 MILLIOHMS MAX. AFTER
DURABILITY TEST.

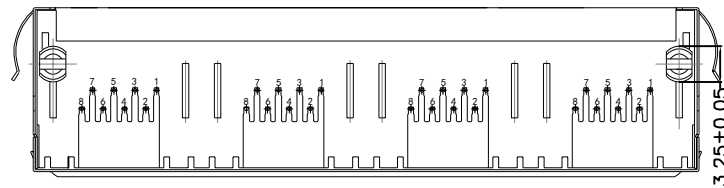

BOTTOM VIEW

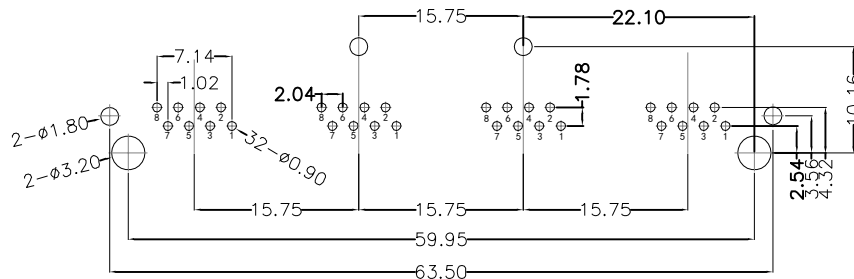

RECOMMENDED PCB LAYOUT
VIEWED FROM COMPONENT SIDE

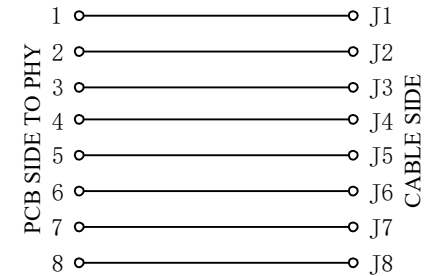

DGKYD

东莞市科优达电子科技有限公司
Dong Guan Ke You Da Electronic Tech.Co.,Ltd

ADD: No.1 LiHe Street,LiHeng Village,Qingxi town, DongGuan City,GuangDong Province
Tel:+86-0769-87334608; Fax:+86-0769-87847129 WWW.DGKYD.COM

TITLE:
RJ45 1*4 56无灯 8P8C

PART NO.:
DGKYD561488HWA1DY1022

REMARK:

SIZE
A4

SACLE
1:1

SHEET
1/2

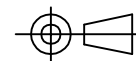

GENERAL TOLERANCES
UNLESS SPECIFIED

$x\pm 0.35$	$x^{\circ}\pm 3.0^{\circ}$
$.x\pm 0.30$	$.x^{\circ}\pm 2.0^{\circ}$
$.xx\pm 0.25$	$.xx^{\circ}\pm 1.5^{\circ}$
$.xxx\pm 0.10$	$.xxx^{\circ}\pm 1.0^{\circ}$

APPROVED BY:
JP.Gong

CHECKED BY:
TW.Xu

DESIGND BY:
ZG.Hu

REACH & RoHS
COMPLIANT

REV.	ECN / DESCRIPTION	BY	DATE
A0	NEW	ZG.Hu	2018.09.20

Suggested Panel Opening:

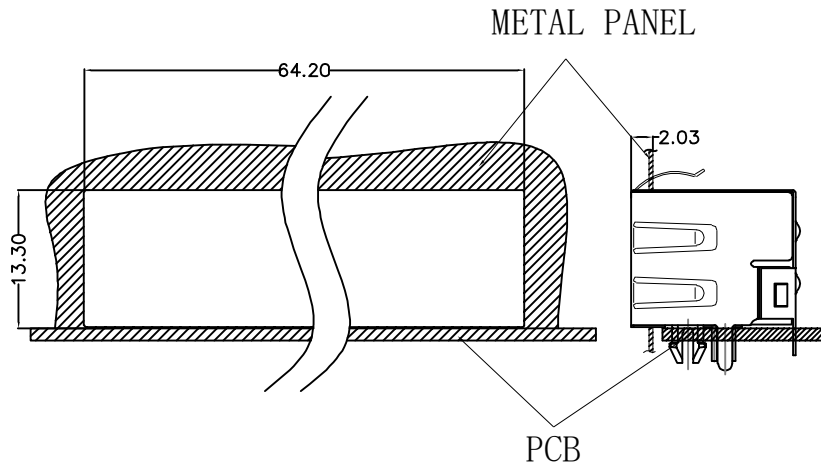

UNIT: mm / inch
Tolerances: $\pm 0.10 / 0.004$

Keep-Out Area (Component Side View):

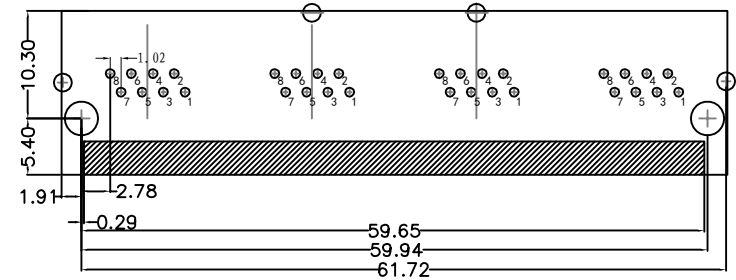

Plug In Side

UNIT: mm / inch
Tolerances: $\pm 0.10 / 0.004$

DGKYD

东莞市科优达电子科技有限公司
Dong Guan Ke You Da Electronic Tech.Co.,Ltd

ADD: No.1 LiHe Street, LiHeng Village, Qingxi town, DongGuan City, GuangDong Province
Tel: +86-0769-87334608; Fax: +86-0769-87847129 WWW.DGKYD.COM

TITLE:
RJ45 1*4 56无灯 8P8C

PART NO.:
DGKYD561488HWA1DY1022

REMARK:

SIZE
A4
UNITS
MM[INCH]

SACLE
1:1
REV
A0

SHEET
2/2

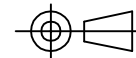

GENERAL TOLERANCES
UNLESS SPECIFIED

$x \pm 0.35$	$x^\circ \pm 3.0^\circ$
$.x \pm 0.30$	$.x^\circ \pm 2.0^\circ$
$.xx \pm 0.25$	$.xx^\circ \pm 1.5^\circ$
$.xxx \pm 0.10$	$.xxx^\circ \pm 1.0^\circ$

APPROVED BY:
JP.Gong

CHECKED BY:
TW.Xu

DESIGND BY:
ZG.Hu